

FLEX 5000 EtherNet/IP Adapters with RJ45 Ports

Catalog Numbers 5094-AENTR, 5094-AENTRXT, 5094-AEN2TR, 5094-AEN2TRXT

Topic	Page
About the Adapter	5
Before You Begin	5
Adapter Dimensions	6
Set the Network Internet Protocol (IP) Address	7
Install the Adapter onto the DIN Rail	8
Connect Power to the Adapter	9
Connect the Adapter to an EtherNet/IP Network	11
Install the End Cap	12
Power the Adapter	13
Remove or Replace the Adapter	13
Specifications	14
Additional Resources	15

Product Overview

The FLEX 5000™ EtherNet/IP Adapters with RJ45 Ports perform the following functions:

- Facilitate high-speed data transfer across an EtherNet/IP network between FLEX 5000 I/O modules and a Logix 5000™ controller.
- Provide system-side power to FLEX 5000 I/O modules.
- The 5094-AENTR and 5094-AENTRXT adapters support as many as 8 FLEX 5000 I/O modules.
- The 5094-AEN2TR and 5094-AEN2TRXT adapters support as many as 16 FLEX 5000 I/O modules.

The adapters are configured with the Studio 5000 Logix Designer® application. For more information on how to use FLEX 5000 EtherNet/IP Adapters with RJ45 Ports, including the compatible Logix 5000 controllers and Logix Designer application versions, see the publications that are listed in [Additional Resources on page 15](#).



ATTENTION: Read this document and the documents listed in the Additional Resources section about installation, configuration and operation of this equipment before you install, configure, operate or maintain this product. Users are required to familiarize themselves with installation and wiring instructions in addition to requirements of all applicable codes, laws, and standards. Activities including installation, adjustments, putting into service, use, assembly, disassembly, and maintenance are required to be carried out by suitably trained personnel in accordance with applicable code of practice.

If this equipment is used in a manner not specified by the manufacturer, the protection provided by the equipment may be impaired.

注意: 在安装、配置、操作和维护本产品前，请阅读本文档以及“其他资源”部分列出的有关设备安装、配置和操作的相应文档。除了所有适用规范、法律和标准的相关要求之外，用户还必须熟悉安装和接线说明。

安装、调整、投运、使用、组装、拆卸和维护等各项操作必须由经过适当训练的专业人员按照适用的操作规范实施。

如果未按照制造商指定的方式使用该设备，则可能会损害设备提供的保护。

ATENCIÓN: Antes de instalar, configurar, poner en funcionamiento o realizar el mantenimiento de este producto, lea este documento y los documentos listados en la sección Recursos adicionales acerca de la instalación, configuración y operación de este equipo. Los usuarios deben familiarizarse con las instrucciones de instalación y cableado y con los requisitos de todos los códigos, leyes y estándares vigentes.

El personal debidamente capacitado debe realizar las actividades relacionadas a la instalación, ajustes, puesta en servicio, uso, ensamblaje, desensamblaje y mantenimiento de conformidad con el código de práctica aplicable.

Si este equipo se usa de una manera no especificada por el fabricante, la protección provista por el equipo puede resultar afectada.

ATENÇÃO: Leia este e os demais documentos sobre instalação, configuração e operação do equipamento que estão na seção Recursos adicionais antes de instalar, configurar, operar ou manter este produto. Os usuários devem se familiarizar com as instruções de instalação e fiação além das especificações para todos os códigos, leis e normas aplicáveis.

É necessário que as atividades, incluindo instalação, ajustes, colocação em serviço, utilização, montagem, desmontagem e manutenção sejam realizadas por pessoal qualificado e especializado, de acordo com o código de prática aplicável.

Caso este equipamento seja utilizado de maneira não estabelecida pelo fabricante, a proteção fornecida pelo equipamento pode ficar prejudicada.

ВНИМАНИЕ: Перед тем как устанавливать, настраивать, эксплуатировать или обслуживать данное оборудование, прочитайте этот документ и документы, перечисленные в разделе «Дополнительные ресурсы». В этих документах изложены сведения об установке, настройке и эксплуатации данного оборудования. Пользователи обязаны ознакомиться с инструкциями по установке и прокладке соединений, а также с требованиями всех применимых норм, законов и стандартов.

Все действия, включая установку, наладку, ввод в эксплуатацию, использование, сборку, разборку и техническое обслуживание, должны выполняться обученным персоналом в соответствии с применимыми нормами и правилами.

Если оборудование используется не предусмотренным производителем образом, защита оборудования может быть нарушена.

注意: 本製品を設置、構成、稼動または保守する前に、本書および本機器の設置、設定、操作についての参考資料の該当箇所に記載されている文書に目を通してください。ユーザは、すべての該当する条例、法律、規格の要件に加えて、設置および配線の手順に習熟している必要があります。

設置調整、運転の開始、使用、組立て、解体、保守を含む諸作業は、該当する実施規則に従って訓練を受けた適切な作業員が実行する必要があります。本機器が製造メーカーにより指定されていない方法で使用されている場合、機器により提供されている保護が損なわれる恐れがあります。

ACHTUNG: Lesen Sie dieses Dokument und die im Abschnitt „Weitere Informationen“ aufgeführten Dokumente, die Informationen zu Installation, Konfiguration und Bedienung dieses Produkts enthalten, bevor Sie dieses Produkt installieren, konfigurieren, bedienen oder warten. Anwender müssen sich neben den Bestimmungen aller anwendbaren Vorschriften, Gesetze und Normen zusätzlich mit den Installations- und Verdrahtungsanweisungen vertraut machen.

Arbeiten im Rahmen der Installation, Anpassung, Inbetriebnahme, Verwendung, Montage, Demontage oder Instandhaltung dürfen nur durch ausreichend geschulte Mitarbeiter und in Übereinstimmung mit den anwendbaren Ausführungsvorschriften vorgenommen werden.

Wenn das Gerät in einer Weise verwendet wird, die vom Hersteller nicht vorgesehen ist, kann die Schutzfunktion beeinträchtigt sein.

ATTENTION: Lisez ce document et les documents listés dans la section Ressources complémentaires relatifs à l'installation, la configuration et le fonctionnement de cet équipement avant d'installer, configurer, utiliser ou entretenir ce produit. Les utilisateurs doivent se familiariser avec les instructions d'installation et de câblage en plus des exigences relatives aux codes, lois et normes en vigueur.

Les activités relatives à l'installation, le réglage, la mise en service, l'utilisation, l'assemblage, le démontage et l'entretien doivent être réalisées par des personnes formées selon le code de pratique en vigueur. Si cet équipement est utilisé d'une façon qui n'a pas été définie par le fabricant, la protection fournie par l'équipement peut être compromise.

주의: 본 제품 설치, 설정, 작동 또는 유지 보수하기 전에 본 문서를 포함하여 설치, 설정 및 작동에 관한 참고 자료 섹션의 문서들을 반드시 읽고 숙지하십시오. 사용자는 모든 관련 규정, 법규 및 표준에서 요구하는 사항에 대해 반드시 설치 및 배선 지침을 숙지해야 합니다.

설치, 조정, 가동, 사용, 조립, 분해, 유지보수 등 모든 작업은 관련 규정에 따라 적절한 교육을 받은 사용자를 통해서만 수행해야 합니다.

본 장비를 제조사가 명시하지 않은 방법으로 사용하면 장비의 보호 기능이 손상될 수 있습니다.

ATTENZIONE: Prima di installare, configurare ed utilizzare il prodotto, o effettuare interventi di manutenzione su di esso, leggere il presente documento ed i documenti elencati nella sezione "Altre risorse", riguardanti l'installazione, la configurazione ed il funzionamento dell'apparecchiatura. Gli utenti devono leggere e comprendere le istruzioni di installazione e cablaggio, oltre ai requisiti previsti dalle leggi, codici e standard applicabili.

Le attività come installazione, regolazioni, utilizzo, assemblaggio, disassemblaggio e manutenzione devono essere svolte da personale adeguatamente addestrato, nel rispetto delle procedure previste.

Qualora l'apparecchio venga utilizzato con modalità diverse da quanto previsto dal produttore, la sua funzione di protezione potrebbe venire compromessa.

DIKKAT: Bu ürünün kurulumu, yapılandırılması, işletilmesi veya bakımı öncesinde bu dokümanı ve bu ekipmanın kurulumu, yapılandırılması ve işletimi ile ilgili ilave Kaynaklar bölümünde yer listelenmiş dokümanları okuyun. Kullanıcılar yürürlükteki tüm yönetmelikler, yasalar ve standartların gereksinimlerine ek olarak kurulum ve kablolama talimatlarını da öğrenmek zorundadır.

Kurulum, ayarlama, hizmete alma, kullanma, parçaları birleştirme, parçaları sökme ve bakım gibi aktiviteler sadece uygun eğitimleri almış kişiler tarafından yürürlükteki uygulama yönetmeliklerine uygun şekilde yapılabilir.

Bu ekipman üretici tarafından belirlenmiş amacın dışında kullanılırsa, ekipman tarafından sağlanan koruma bozulabilir.

注意事項: 在安装、設定、操作或維護本產品前，請先閱讀此文件以及列於「其他資源」章節中有關安裝、設定與操作此設備的文件。使用者必須熟悉安裝和配線指示，並符合所有法規、法律和標準要求。

包括安裝、調整、交付使用、使用、組裝、拆卸和維護等動作都必須交由已經過適當訓練的人員進行，以符合適用的實作法規。

如果將設備用於非製造商指定的用途時，可能會造成設備所提供的保護功能受損。

POZOR: Než začnete instalovat, konfigurovat či provozovat tento výrobek nebo provádět jeho údržbu, přečtěte si tento dokument a dokumenty uvedené v části Dodatečné zdroje ohledně instalace, konfigurace a provozu tohoto zařízení. Uživatelé se musejí vedle požadavků všech relevantních vyhlášek, zákonů a norem nutně seznámit také s pokyny pro instalaci a elektrické zapojení.

Činnosti zahrnující instalaci, nastavení, uvedení do provozu, užívání, montáž, demontáž a údržbu musí vykonávat vhodně proškolený personál v souladu s příslušnými prováděcími předpisy.

Pokud se toto zařízení používá způsobem neodpovídajícím specifikaci výrobce, může být narušena ochrana, kterou toto zařízení poskytuje.

UWAGA: Przed instalacją, konfiguracją, użytkowaniem lub konserwacją tego produktu należy przeczytać niniejszy dokument oraz wszystkie dokumenty wymienione w sekcji Dodatkowe źródła omawiające instalację, konfigurację i procedury użytkowania tego urządzenia. Użytkownicy mają obowiązek zapoznać się z instrukcjami dotyczącymi instalacji oraz oprzewodowania, jak również z obowiązującymi kodeksami, prawem i normami.

Działania obejmujące instalację, regulację, przekazanie do użytkowania, użytkowanie, montaż, demontaż oraz konserwację muszą być wykonywane przez odpowiednio przeszkolony personel zgodnie z obowiązującym kodeksem postępowania.

Jeśli urządzenie jest użytkowane w sposób inny niż określony przez producenta, zabezpieczenie zapewniane przez urządzenie może zostać ograniczone.

OBSE! Läs detta dokument samt dokumentet, som står listat i avsnittet Övriga resurser, om installation, konfigurering och drift av denna utrustning innan du installerar, konfigurerar eller börjar använda eller utföra underhållsarbete på produkten. Användare måste bekanta sig med instruktioner för installation och kabeldragning, förutom krav enligt gällande koder, lagar och standarder.

Åtgärder som installation, justering, service, användning, montering, demontering och underhållsarbete måste utföras av personal med lämplig utbildning enligt lämpligt bruk.

Om denna utrustning används på ett sätt som inte anges av tillverkaren kan det hända att utrustningens skyddsanordningar försätts ur funktion.

LET OP: Lees dit document en de documenten die genoemd worden in de paragraaf Aanvullende informatie over de installatie, configuratie en bediening van deze apparatuur voordat u dit product installeert, configureert, bedient of onderhoudt. Gebruikers moeten zich vertrouwd maken met de installatie en de bedradinginstructies, naast de vereisten van alle toepasselijke regels, wetten en normen.

Activiteiten zoals het installeren, afstellen, in gebruik stellen, gebruiken, monteren, demonteren en het uitvoeren van onderhoud mogen uitsluitend worden uitgevoerd door hiervoor opgeleid personeel en in overeenstemming met de geldende praktijkregels.

Indien de apparatuur wordt gebruikt op een wijze die niet is gespecificeerd door de fabrikant, dan bestaat het gevaar dat de beveiliging van de apparatuur niet goed werkt.

Environment and Enclosure



ATTENTION: This equipment is intended for use in a Pollution Degree 2 industrial environment, in overvoltage Category II applications (as defined in EN/IEC 60664-1), at altitudes up to 2000 m (6562 ft) without derating.

This equipment is not intended for use in residential environments and may not provide adequate protection to radio communication services in such environments.

This equipment is supplied as open-type equipment for indoor use. It must be mounted within an enclosure that is suitably designed for those specific environmental conditions that will be present and appropriately designed to prevent personal injury resulting from accessibility to live parts. The enclosure must have suitable flame-retardant properties to prevent or minimize the spread of flame, complying with a flame spread rating of 5VA or be approved for the application if nonmetallic. The interior of the enclosure must be accessible only by the use of a tool. Subsequent sections of this publication may contain more information regarding specific enclosure type ratings that are required to comply with certain product safety certifications.

In addition to this publication, see the following:

- Industrial Automation Wiring and Grounding Guidelines, publication [1770-4.1](#), for more installation requirements.
- NEMA Standard 250 and EN/IEC 60529, as applicable, for explanations of the degrees of protection provided by enclosures.

North American Hazardous Location Approval

<p>The following information applies when operating this equipment in hazardous locations:</p>	<p>Informations sur l'utilisation de cet équipement en environnements dangereux:</p>
<p>Products marked "CL I, DIV 2, GP A, B, C, D" are suitable for use in Class I Division 2 Groups A, B, C, D, Hazardous Locations and nonhazardous locations only. Each product is supplied with markings on the rating nameplate indicating the hazardous location temperature code. When combining products within a system, the most adverse temperature code (lowest "T" number) may be used to help determine the overall temperature code of the system. Combinations of equipment in your system are subject to investigation by the local Authority Having Jurisdiction at the time of installation.</p>	<p>Les produits marqués "CL I, DIV 2, GP A, B, C, D" ne conviennent qu'à une utilisation en environnements de Classe I Division 2 Groupes A, B, C, D dangereux et non dangereux. Chaque produit est livré avec des marquages sur sa plaque d'identification qui indiquent le code de température pour les environnements dangereux. Lorsque plusieurs produits sont combinés dans un système, le code de température le plus défavorable (code de température le plus faible) peut être utilisé pour déterminer le code de température global du système. Les combinaisons d'équipements dans le système sont sujettes à inspection par les autorités locales qualifiées au moment de l'installation.</p>
<div style="display: flex; align-items: center;"> <div> <p>WARNING EXPLOSION HAZARD</p> <ul style="list-style-type: none"> • Do not disconnect equipment unless power has been removed or the area is known to be nonhazardous. • Do not disconnect connections to this equipment unless power has been removed or the area is known to be nonhazardous. Secure any external connections that mate to this equipment by using screws, sliding latches, threaded connectors, or other means provided with this product. • Substitution of components may impair suitability for Class I, Division 2. • If this product contains batteries, they must be changed only in an area known to be nonhazardous. </div> </div>	<div style="display: flex; align-items: center;"> <div> <p>AVERTISSEMENT RISQUE D'EXPLOSION</p> <ul style="list-style-type: none"> • Couper le courant ou s'assurer que l'environnement est classé non dangereux avant de débrancher l'équipement. • Couper le courant ou s'assurer que l'environnement est classé non dangereux avant de débrancher les connecteurs. Fixer tous les connecteurs externes reliés à cet équipement à l'aide de vis, loquets coulissants, connecteurs filetés ou autres moyens fournis avec ce produit. • La substitution de composants peut rendre cet équipement inadéquat à une utilisation en environnement de Classe I, Division 2. • S'assurer que l'environnement est classé non dangereux avant de changer les piles. </div> </div>

European Hazardous Location Approval

<p>The following applies to products marked CE, Ex II 3 G. Such modules:</p> <ul style="list-style-type: none"> • Are Equipment Group II, Equipment Category 3, and comply with the Essential Health and Safety Requirements relating to the design and construction of such equipment given in Annex II to Directive 2014/34/EU. See the EC Declaration of Conformity at http://www.rockwellautomation.com/products/certification for details. • The type of protection is "Ex nA IIC T4 Gc" according to EN 60079-15. • Comply to Standards EN 60079-0:2012+A11:2013, EN 60079-15:2010, reference certificate number DEMKO17ATEX1898X. • Are intended for use in areas in which explosive atmospheres caused by gases, vapors, mists, or air are unlikely to occur, or are likely to occur only infrequently and for short periods. Such locations correspond to Zone 2 classification according to ATEX directive 2014/34/EU.

IEC Hazardous Location Approval

<p>The following applies to products with IECEx certification: Such modules:</p> <ul style="list-style-type: none"> • Are intended for use in areas in which explosive atmospheres caused by gases, vapors, mists, or air are unlikely to occur, or are likely to occur only infrequently and for short periods. Such locations correspond to Zone 2 classification to IEC 60079-0. • The type of protection is "Ex nA IIC T4 Gc" according to IEC 60079-15. • Comply to Standards IEC 60079-0:2011, IEC 60079-15:2010, reference IECEx certificate number IECEx UL17.0047X.



WARNING: Special Conditions for Safe Use:

- This equipment shall be mounted in an ATEX/IECEx Zone 2 certified enclosure with a minimum ingress protection rating of at least IP54 (in accordance with EN/IEC 60079-15) and used in an environment of not more than Pollution Degree 2 (as defined in EN/IEC 60664-1) when applied in Zone 2 environments. The enclosure must be accessible only by the use of a tool.
- This equipment shall be used within its specified ratings defined by Rockwell Automation.
- Provision shall be made to prevent the rated voltage from being exceeded by transient disturbances of more than 140% of the peak rated voltage when applied in Zone 2 environments.
- The instructions in the user manual shall be observed.
- This equipment must be used only with ATEX/IECEx certified Rockwell Automation backplanes.
- Secure any external connections that mate to this equipment by using screws, sliding latches, threaded connectors, or other means provided with this product.
- Do not disconnect equipment unless power has been removed or the area is known to be nonhazardous.
- The installer shall ensure that the service temperature of the suitably-certified enclosure and the “maximum ambient” temperature of the module when installed is not exceeded.

Prevent Electrostatic Discharge



ATTENTION: This equipment is sensitive to electrostatic discharge, which can cause internal damage and affect normal operation. Follow these guidelines when you handle this equipment:

- Touch a grounded object to discharge potential static.
- Wear an approved grounding wriststrap.
- Do not touch connectors or pins on component boards.
- Do not touch circuit components inside the equipment.
- Use a static-safe workstation, if available.
- Store the equipment in appropriate static-safe packaging when not in use.

Electrical Safety Considerations



ATTENTION:

- All wiring must comply with applicable electrical installation requirements (e.g., N.E.C. article 501-4(b)).
- Wire conductor and insulation ratings shall support minimum temperature rating of 85 °C (185 °F).
- Do not wire more than 2 conductors on any terminal.
- In case of malfunction or damage, no attempts at repair should be made. The module should be returned to the manufacturer for repair. Do not dismantle the module.
- This equipment is certified for use only within the surrounding air temperature range of -40...+70 °C (-40...+158 °F). The equipment must not be used outside of this range.
- Use only a soft dry anti-static cloth to wipe down equipment. Do not use any cleaning agents.



WARNING:

- If you connect or disconnect wiring while the field-side power is on, an electric arc can occur. This could cause an explosion in hazardous location installations. Be sure that power is removed or the area is nonhazardous before proceeding.
- When used in a Class I, Division 2, hazardous location, this equipment must be mounted in a suitable enclosure with proper wiring method that complies with the governing electrical codes.
- Do not connect directly to line voltage. Line voltage must be supplied by a suitable, approved isolating transformer.

IMPORTANT

Any illustrations, charts, sample programs, and layout examples shown in this publication are intended solely for the purposes of example. Since there are many variables and requirements associated with any particular installation, Rockwell Automation does not assume responsibility or liability for actual use based upon the examples shown in this publication.



At the end of its life, this equipment should be collected separately from any unsorted municipal waste.

About the Adapter

FLEX 5000 EtherNet/IP Adapter with RJ45 Ports

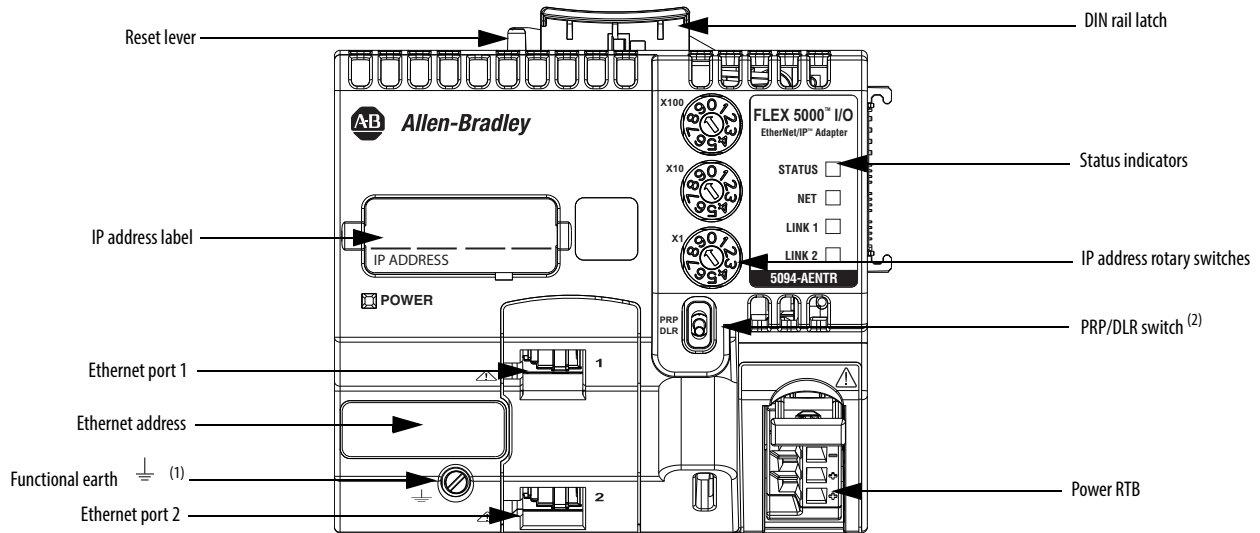

(1) Functional earth must be grounded. See [Ground Considerations on page 7](#) for more information.

(2) Refer to the following **IMPORTANT** statement about the PRP/DLR switch for more information.

IMPORTANT You must set the PRP/DLR switch to the DLR position. If you set the switch to the PRP position, the adapter cannot establish connection with the I/O modules.

Before You Begin

Before you install the adapter, verify that you have the following:

Components Needed to Install a FLEX 5000 EtherNet/IP Adapter with RJ45 Ports

Component	Description
Removable terminal block (RTB)	Your adapter comes with a screw-type RTB. You can order screw-type or spring-type RTBs separately: <ul style="list-style-type: none"> • 5094-AENRTB-QTY5 – Ethernet Adapter RTB, Screw-type, Pack of 5 • 5094-AENRTBS-QTY5 – Ethernet Adapter RTB, Spring-type, Pack of 5
External power supply for module power	A power supply that is adequately sized to provide module power, that is, system-side power, to the FLEX 5000 I/O modules. For more information, see Power Considerations on page 7 .
Tools	You need the following tools: <ul style="list-style-type: none"> • Screwdriver • Wire stripper • Wires For more information on available wire sizes and wire insulation stripping length, see Specifications on page 14 .
DIN rail	Compatible zinc-plated, yellow-chromate steel DIN rail. You can use a steel DIN rail such as the Allen-Bradley 199-DR1; 46277-3; EN50022 – 35 x 7.5 mm (1.38 x 0.30 in.).
EtherNet/IP network components	You must install the network and all required components.
Software	If you do not use the rotary switches to set the adapter IP address, you can use the following software to set the IP address: <ul style="list-style-type: none"> • DHCP server • BootP DHCP EtherNet/IP Commissioning Tool • RSLinx® Classic software For more information, see Set the Network Internet Protocol (IP) Address on page 7 .

System Planning

Follow these rules when planning your system configuration:

- The FLEX 5000 EtherNet/IP adapter must be installed left-most to the FLEX 5000 I/O modules.
- Local FLEX 5000 I/O modules are installed to the right of the FLEX 5000 EtherNet/IP adapter.
- The 5094-AENTR and 5094-AENRXT adapters support as many as 8 FLEX 5000 I/O modules.
- The 5094-AEN2TR and 5094-AEN2TRXT adapters support as many as 16 FLEX 5000 I/O modules.
- Before powerup, verify that the end cap is installed on the right-most installed FLEX 5000 terminal base.



ATTENTION: Do not discard the end cap. Use this end cap to cover the exposed interconnections on the adapter module or the last terminal base on the DIN rail. Failure to do so could result in equipment damage or injury from electric shock. See [Install the End Cap on page 12](#) for more information.

Spacing

Maintain spacing from enclosure walls, wireways, and adjacent equipment. You can mount the DIN rail horizontally or vertically.

FLEX 5000 EtherNet/IP Adapter with RJ45 Ports Spacing

Horizontal Mounting

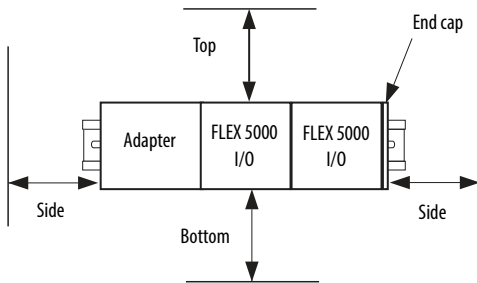

IMPORTANT: Allow 25.4 mm (1.00 in.) of space on all sides for adequate ventilation.

Vertical Mounting

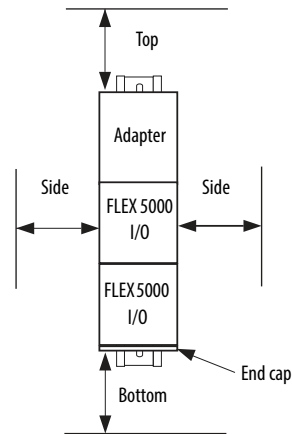

Adapter Dimensions

FLEX 5000 EtherNet/IP Adapter with RJ45 Ports Dimensions

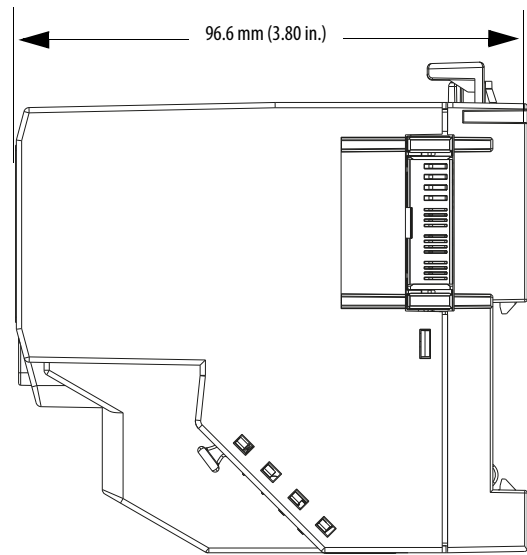
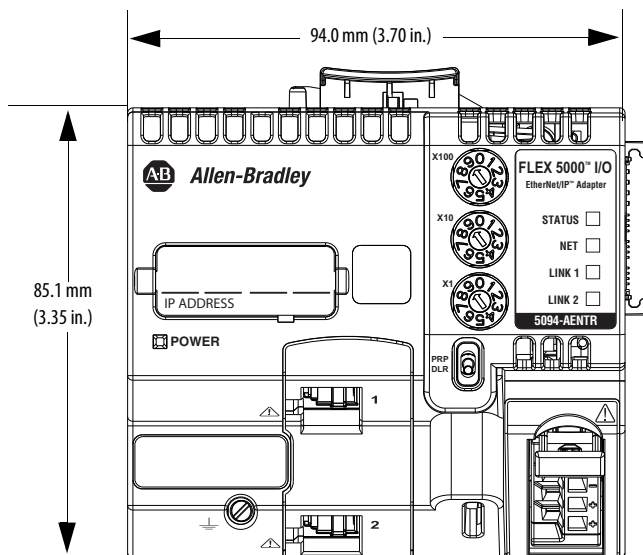

Ground Considerations

You must ground DIN rails according to the Industrial Automation Wiring and Grounding Guidelines, publication [1770-4.1](#).



ATTENTION: This product is grounded through the DIN rail to chassis ground. Use zinc-plated yellow-chromate steel DIN rail to assure proper grounding. The use of other DIN rail materials (for example, aluminum or plastic) that can corrode, oxidize, or are poor conductors can result in improper or intermittent grounding. Secure DIN rail to mounting surface approximately every 200 mm (7.8 in.) and use end-anchors appropriately. Be sure to ground the DIN rail properly. Refer to Industrial Automation Wiring and Grounding Guidelines, Rockwell Automation publication [1770-4.1](#) for more information.

You can use a zinc-plated yellow-chromate steel DIN rail such as the Allen-Bradley 199-DR1; 46277-3; EN50022 – 35 x 7.5 mm (1.38 x 0.30 in.).

Power Considerations



ATTENTION: Power to this equipment and all connected I/O must be supplied from a source compliant with the following:
Isolated from Mains power via an approved Isolating Transformer constructed with Basic Insulation

The FLEX 5000 EtherNet/IP adapter is powered by a Power RTB that is connected to an external power supply and installed on the adapter.

The Power RTB also provides module power through the backplane to operate the FLEX 5000 I/O modules.

- You must limit the module power source to **10 A, max, at 18...32V DC**.
- Confirm that the external module power supply is adequately sized for all installed modules.
For example, if the total module power current draw, including current inrush requirements, is 5 A, you can use a module power supply that is limited to 5 A.
- We recommend the following power supplies for each FLEX 5000 EtherNet/IP adapter:
 - **1606-XLP72E** power supply for **5094-AENTR** and **5094-AENTRXT** adapters
 - **1606-XLE80E** power supply for **5094-AEN2TR** and **5094-AEN2TRXT** adapters
 For more information, refer to Switched Mode Power Supplies Technical Data, publication [1606-TD002](#).
- You must use SELV-listed power supplies for module power if you are using Functional Safety modules.
- Not all power supplies are certified for use in all applications, for example, nonhazardous and hazardous environments.

IMPORTANT We recommend that you use separate external power supplies for the adapter and the adjacent terminal base. This practice can prevent unintended consequences that can result if you use one supply.

For more information, see the publications that are listed in [Additional Resources on page 15](#)

Set the Network Internet Protocol (IP) Address

FLEX 5000 EtherNet/IP Adapters with RJ45 Ports ship DHCP-enabled and with their rotary switches set to 999.

If the network uses 192.168.1.x, we recommend that you use the rotary switches to set the last octet of network IP address. Valid numbers range from 001...254.

To use the rotary switches to set the IP address, turn the switches to the appropriate numbers before you install the adapter.

The bottom switch represents the first digit in the octet, the middle switch represents the second digit, and the top switch represents the third digit.

FLEX 5000 EtherNet/IP Adapter with RJ45 Ports Rotary Switches

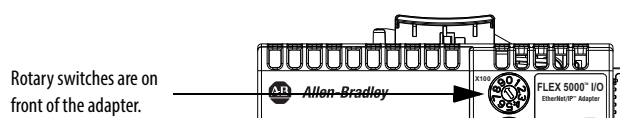



WARNING: When you change switch settings while power is on, an electric arc can occur. This could cause an explosion in hazardous location installations. Be sure that power is removed or the area is nonhazardous before proceeding.

At powerup, the adapter reads the rotary switches to determine if they are set to a valid number for the last octet of the IP address. If the settings are a valid number, these conditions result:

IP address = 192.168.1.xxx (where xxx represents the switch settings)

- Subnet mask = 255.255.255.0
- Gateway address = 0.0.0.0
- The adapter does not have an assigned host name, nor does it use any Domain Name System

If the network does not use 192.168.1.x, do not change the switch positions before you install the adapter. After you install and power up the adapter, you can use the following to set the network IP address:

- DHCP server
- BootP DHCP EtherNet/IP Commissioning Tool - FLEX 5000 EtherNet/IP Adapters with RJ45 Ports only use the DHCP mode
- RSLinx Classic software

To reset the adapter to its initial out-of-the-box settings, set the rotary switches to 888 and cycle power.

For more information on how to use software to set the IP address, see the EtherNet/IP Communication Modules in Logix 5000 Control Systems User Manual, publication [ENET-UM004](#).

Install the Adapter onto the DIN Rail

The adapter must be installed left-most to the I/O modules.



ATTENTION: During DIN rail mounting of all devices, be sure that all debris (metal chips, wire strands) is kept from falling into the adapter or modules. Debris that falls into the adapter or modules could cause damage on powerup.



WARNING: If you insert or remove the module while backplane power is on, an electric arc can occur. This could cause an explosion in hazardous location installations. Be sure that power is removed or the area is nonhazardous before proceeding.

1. Make sure that the DIN rail latch is in the Locked position.

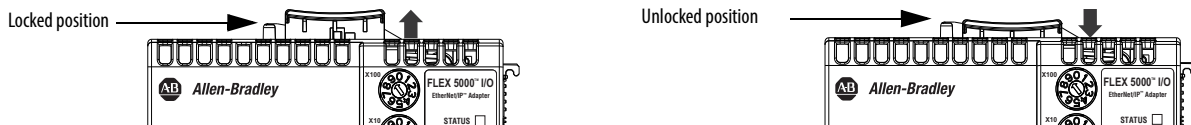

2. If the DIN rail latch is in the Unlocked position, gently press the Reset lever until the DIN rail latch pops out to the Locked position.

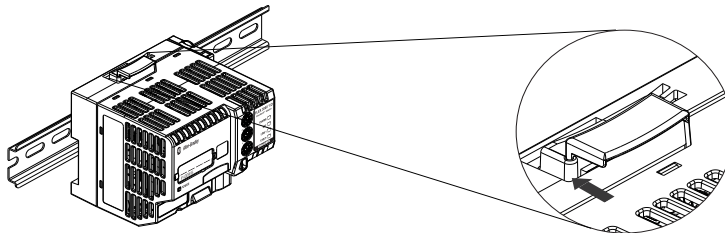

3. Position the adapter so that the back of it faces the DIN rail.
4. Press the adapter against the DIN rail until it clicks.
5. Make sure that the adapter is latched securely.

Connect Power to the Adapter

Before you connect power to a FLEX 5000 EtherNet/IP adapter, complete the following tasks:

- Read [Power Considerations on page 7](#).
- Confirm that the external power supply that supplies module power is adequately sized all installed modules. For more information, see [Power Considerations on page 7](#).
- Install the Power RTB on the adapter before you connect power to the adapter.

Install the Power RTB



WARNING: If you connect or disconnect the removable terminal block (RTB) with power applied, an electric arc can occur. This could cause an explosion in hazardous location installations.

The removable terminal block (RTB) does not support “removal and insertion under power” (RIUP) capability. Do not connect or disconnect the removable terminal block (RTB) while power is applied. Be sure that power is removed before proceeding.

1. If the Power RTB lever is pushed in, pull the lever until it fully extends and clicks.

Power RTB lever pushed in

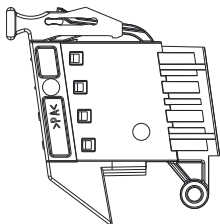

Power RTB lever fully extended

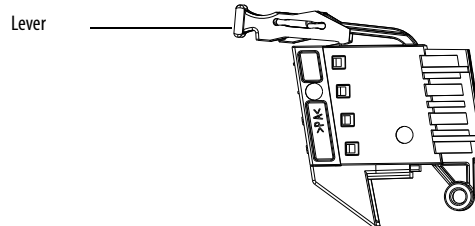

2. Insert the Power RTB into the RTB slot as shown in the graphic and press it until it clicks.

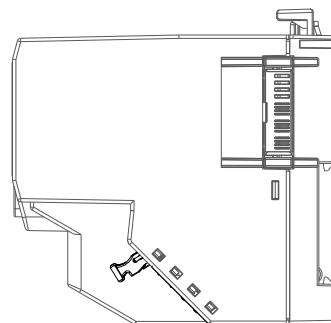
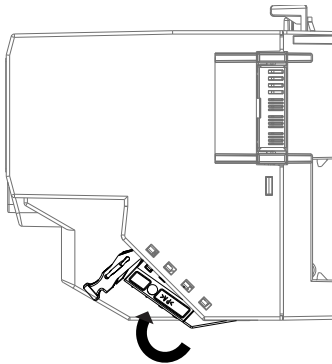

3. Press the lever until it clicks.

The Power RTB is locked into the adapter.

Connect Power to the Power RTB

Before you connect an external power source to the Power RTB terminals, make sure that the power source is properly sized. For example, if the total module power current draw, including current inrush requirements, is 4 A, you can use a power supply that is limited to 4 A.

IMPORTANT Your application can require a power control device, for example, a switch, between the external 24V DC power source and the adapter to control when the module is powered. If so, you must install the power control device at the VDC+ terminal on the removable terminal block.

If you install the power control device at the VDC- terminal, the adapter can fail to power up or power down properly.

1. Verify that the external power supply is not powered.

- Strip insulation from the wires that you connect to the Power RTB.

RTB Type	Action
Screw	0.33...2.1 mm ² (22...14 AWG) = Strip 12 ± 1 mm (0.47 ± 0.04 in.) of insulation from the wires.
Spring	0.33...1.3 mm ² (22...16 AWG) = Strip 10 ± 1 mm (0.39 ± 0.04 in.) of insulation from the wires. 2.1 mm ² (14 AWG) = Strip 15 ± 1 mm (0.59 ± 0.04 in.) of insulation from the wires.

For more information, refer to [Specifications on page 14](#).

- Connect the 24V DC (-) wire from the external power supply to any - terminal.

RTB Type	Action
Screw	1. Insert the wire into the terminal. 2. Turn the screwdriver to close the terminal on the wire. Torque the screw to 0.4 N·m (3.5 lb·in).
Spring	Push the wire into the terminal. If the wire is too thin, crimp a wire ferrule on the wire and insert it.

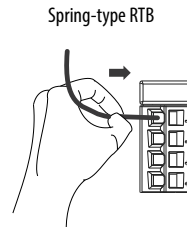
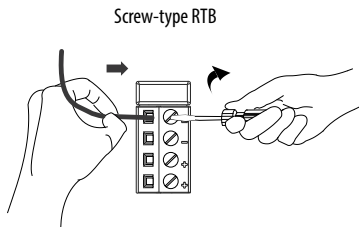

- Connect the 24V DC (+) wire from the external power supply to any + terminal.

RTB Type	Action
Screw	1. Insert the wire into the terminal. 2. Turn the screwdriver to close the terminal on the wire. Torque the screw to 0.4 N·m (3.5 lb·in).
Spring	Push the wire into the terminal. If the wire is too thin, crimp a wire ferrule on the wire and insert it.

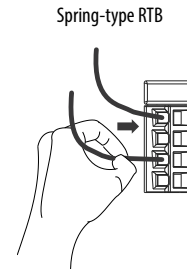
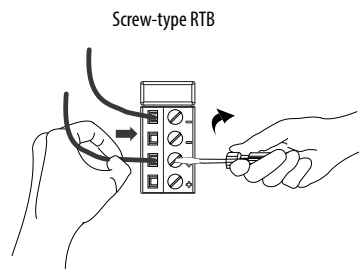

Disconnect Wires from the Power RTB



WARNING: If you connect or disconnect wiring while power is applied, an electrical arc can occur. This could cause an explosion in hazardous location installations. Be sure that power is removed or the area is nonhazardous before proceeding.

If necessary, complete the following tasks to disconnect wires from the Power RTB on the adapter.

RTB Type	Action
Screw	<ol style="list-style-type: none"> 1. Turn the screwdriver counter-clockwise to open the terminal. 2. Remove the wire.
Spring	<ol style="list-style-type: none"> 1. Insert and hold a screwdriver in the right-side terminal. 2. Remove the wire. 3. Pull out the screwdriver.

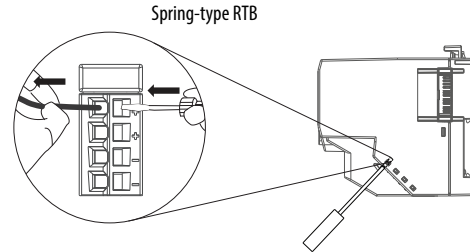
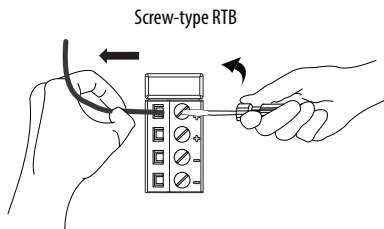

IMPORTANT When you insert a screwdriver to disconnect wires, follow the entry angle on the right-side terminal of a spring-type RTB.

Connect the Adapter to an EtherNet/IP Network

Use an RJ45 straight cable to connect the adapter to an EtherNet/IP network.



WARNING: If you connect or disconnect the communication cable with power applied to this module or any device on the network, an electric arc can occur. This could cause an explosion in hazardous location installations.

Be sure that power is removed or the area is nonhazardous before proceeding.

This warning applies to connections to ports 1 and 2 on both adapters. For more information on where the ports are located on the adapter, see [About the Adapter on page 5](#).

1. If needed, wire the RJ45 connector as shown.

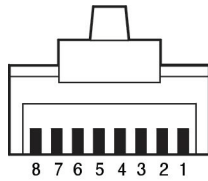

Connector Number	Color	1585J 8-pin Cables with Support for 10/100/1000 Mbps	1585J 8-pin Cables with Support for 10/100 Mbps	1585J 4-pin Cables with Support for 10/100 Mbps
1	White/Orange	BI_DA+	TxData +	
2	Orange	BI_DA-	TxData -	
3	White/Green	BI_DB+	Recv Data +	
4	Blue	BI_DC+	Unused	N/A
5	White/Blue	BI_DC-	Unused	N/A
6	Green	BI_DB-	Recv Data -	
7	White/Brown	BI_DD+	Unused	N/A
8	Brown	BI_DD-	Unused	N/A

2. Connect the RJ45 cable to an Ethernet port of the adapter. You can connect two RJ45 cables to the adapter.

Install the FLEX 5000 I/O Modules

Install FLEX 5000 I/O modules on the right side of the adapter.

If the end cap is installed on the adapter, you must remove it before you can install the I/O modules.

For more information on how to install FLEX 5000 I/O modules, see the installation instructions available with each FLEX 5000 I/O module catalog number.

Install the End Cap

An end cap is shipped with the adapter.

You must install an end cap on the right side of the last installed terminal base. The end cap covers the exposed interconnections on the adapter or on the last installed terminal base. If you do not install the end cap before powering the adapter, equipment damage or injury from electric shock can result.

1. Make sure that the end cap is unlocked.

If the end cap is locked, pull the tab until it clicks.

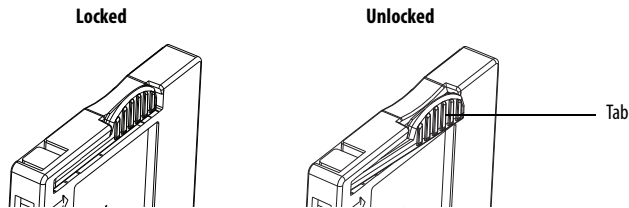

2. Align the end cap with interlocking pieces on the last installed terminal base.

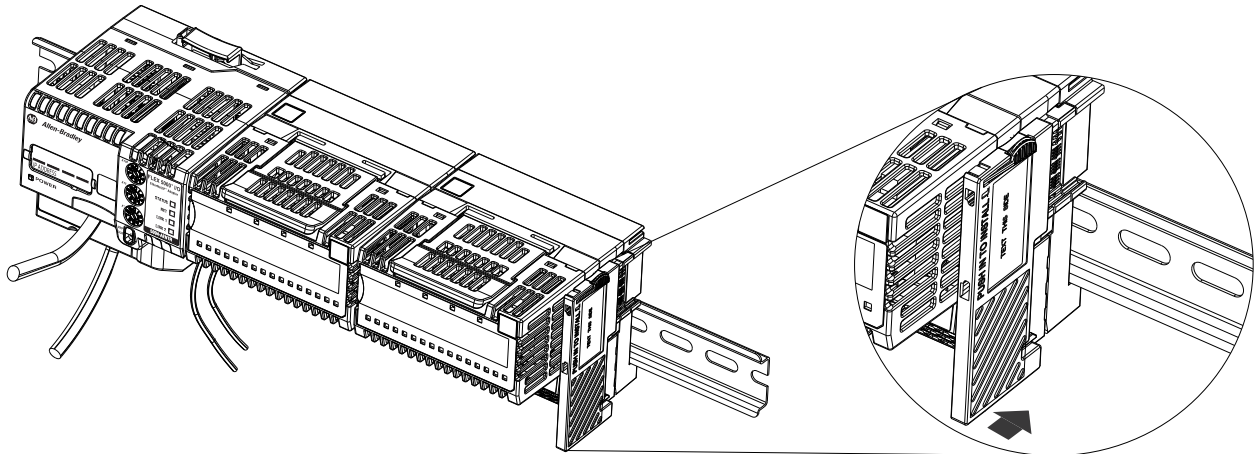

3. Push the end cap towards the DIN rail
4. Press the Locking tab until it clicks.

Install End Anchors onto the DIN Rail

Use DIN rail end anchors (Allen-Bradley part number 1492-EAJ35 or 1492-EAHJ35) for vibration or shock environments. You must install an end anchor to the left of the adapter and to the right of the last installed terminal base to hold the modules firmly in position on the DIN rail.

1. Make sure that the end cap is installed on the last installed terminal base.
2. Slide an end anchor along the left-side of the DIN rail until it touches the adapter.
3. Slide an end anchor along the right-side of the DIN rail until it touches the end cap on the last installed terminal base.
4. Tighten the screw of each end anchor.

Power the Adapter

Once you have installed the end anchors and the modules are held firmly in position on the DIN rail, turn on power to the Power RTB.

Remove or Replace the Adapter



ATTENTION: Do not remove or replace the adapter while power is applied. Interruption of the backplane can result in unintentional operation or machine motion.



WARNING: If you insert or remove the adapter module while power is on, an electric arc can occur. This could cause an explosion in hazardous location installations. The module does not support "removal and insertion under power" (RIUP) capability. Do not connect or disconnect the module while power is applied. Be sure that power is removed before proceeding.

1. Turn off power to the Power RTB.

IMPORTANT When you remove power from a FLEX 5000 EtherNet/IP adapter, you shut down power to all installed FLEX 5000 I/O modules. That is, all system-side power is removed.

2. If there are I/O modules installed, remove the I/O module from the terminal base next to the adapter. For more information on how to remove FLEX 5000 I/O modules, see the installation instructions available with each FLEX 5000 I/O module catalog number.
3. Remove all network cables from the adapter.
4. Pull the lever of the Power RTB and then gently pull the Power RTB off the adapter.

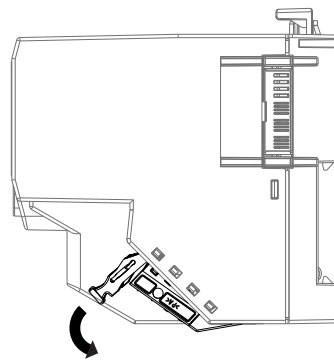
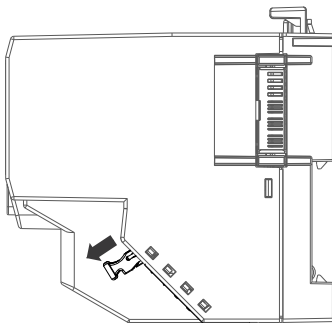

5. Press down the DIN rail latch.
A click indicates that the DIN rail latch is unlocked.

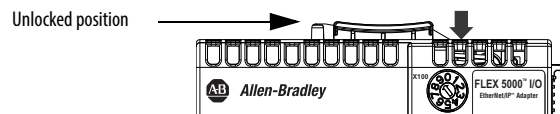
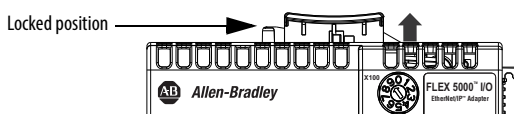

6. Pull the adapter off the DIN rail.
7. To replace the adapter, repeat the installation steps that are described beginning at [Set the Network Internet Protocol \(IP\) Address on page 7.](#)

Specifications

This table includes a subset of specifications for the adapter. For a complete list of specifications, see the FLEX 5000 Modules Specifications Technical Data, publication [5094-TD001](#).

Attribute	5094-AENTR	5094-AENTRXT	5094-AEN2TR	5094-AEN2TRXT
Temperature, operating IEC 60068-2-1 (Test Ad, Operating Cold) IEC 60068-2-2 (Test Bd, Operating Dry Heat) IEC 60068-2-14 (Test Nb, Operating Thermal Shock)	-40 °C < Ta < +70 °C (-40 °F < Ta < +158 °F)			
Temperature, surrounding air, max	70 °C (158 °F)			
Temperature, nonoperating IEC 60068-2-1 (Test Ab, Unpackaged Nonoperating Cold) IEC 60068-2-2 (Test Bb, Unpackaged Nonoperating Dry Heat) IEC 60068-2-14 (Test Na, Unpackaged Nonoperating Thermal Shock)	-40...+85 °C (-40...+185 °F)			
Relative humidity IEC 60068-2-30 (Test Db, Unpackaged Damp Heat)	5...95% noncondensing			
Vibration IEC 60068-2-6 (Test Fc, Operating)	5 g @ 10...500 Hz			
Shock, operating IEC 60068-2-27 (Test Ea, Unpackaged Shock)	30 g			
Shock, nonoperating IEC 60068-2-27 (Test Ea, Unpackaged Shock)	30 g			
Emissions	IEC 61000-6-4			
ESD Immunity IEC 61000-4-2	6 kV contact discharges 8 kV air discharges			
Radiated RF Immunity IEC 61000-4-3	10V/m with 1 kHz sine-wave 80% AM from 80...2000 MHz 10V/m with 200 Hz 50% Pulse 100% AM at 900 MHz 10V/m with 200 Hz 50% Pulse 100% AM at 1890 MHz 10V/m with 1 kHz sine-wave 80% AM from 2000...2700 MHz			
EFT/B Immunity IEC 61000-4-4	±4 kV at 5 kHz on power ports ±4 kV at 5 kHz on Ethernet ports			
Surge Transient Immunity IEC 61000-4-5	±1 kV line-line (DM) and ±2 kV line-earth (CM) on power ports ±2 kV line-earth (CM) on Ethernet ports			
Conducted RF Immunity IEC 61000-4-6	10V rms with 1 kHz sine-wave 80% AM from 150 kHz...80 MHz			
Enclosure type rating	None (open-style)			
Corrosion resistance classification	–	ISA 571.04 G3	–	ISA 571.04 G3
Voltage and current ratings, MP	18...32V DC, 1250mA		18...32V DC, 1880mA	
Voltage and current ratings, MP inrush	18...32V DC, 3200mA for 100ms		18...32V DC, 5700mA for 100ms	
Voltage and current ratings, backplane	15V DC, 1130mA		15V DC, 1800mA	
Power dissipation, max	5.1 W @ 18V DC		6.2 W @ 18V DC	
Thermal dissipation	17.4 BTU/hr @ 24V DC		21.1 BTU/hr @ 24V DC	
Isolation voltage	300V (continuous), Basic Insulation Type Tested at 2121V DC for 60 s, Power to Backplane and Backplane to Ethernet Tested at 4242V DC for 60 s, Power to Ethernet Ports No isolation between Ethernet Ports			
Wire size, Power RTB	0.33...2.1 mm ² (22...14 AWG) solid or stranded copper wire rated at 105°C (221°F), or greater, 1.2 mm (3/64 in.) insulation max, single wire connection only. Ferrule according to DIN 46 228/1.			
Wire size, functional earth terminal	2.1 mm ² (14 AWG) solid or stranded copper wire rated at 105 °C (221 °F), or greater, 3.5mm (0.14in) max diameter including insulation, single wire connection only.			
Terminal block torque, Power RTB	Screw-type RTB: • 0.4 N·m (3.5 lb·in) Spring-type RTB: • Not applicable			

Attribute	5094-AENR	5094-AENRXT	5094-AEN2R	5094-AEN2RXT
Terminal block torque, functional earth terminal	0.5 N-m (4.4 lb-in)			
Insulation stripping length, Power RTB	Screw-type RTB connections: <ul style="list-style-type: none"> • 0.33...2.1 mm² (22...14 AWG) = 12 ± 1 mm (0.47 ± 0.04 in.) Spring-type RTB connections <ul style="list-style-type: none"> • 0.33...1.3 mm² (22...16 AWG) = 10 ± 1 mm (0.39 ± 0.04 in.) • 2.1 mm² (14 AWG) = 15 ± 1 mm (0.59 ± 0.04 in.) 			
Insulation stripping length, functional earth terminal	8 mm (0.31 in.)			
Wiring Category ⁽¹⁾⁽²⁾	1 - on power ports 1 - on Ethernet ports			
Wire Type	Copper			
North American Temp Code	T4			
ATEX Temp Code	T4			
IECEX Temp Code	T4			

(1) Use this Conductor Category information for planning conductor routing. Refer to Industrial Automation Wiring and Grounding Guidelines, publication [1770-4.1](#).

(2) Use this Conductor Category information for planning conductor routing as described in the appropriate System Level Installation Manual.

Additional Resources

For more information on the products that are described in this publication, use these resources.

Resource	Description
FLEX 5000 Modules Specifications Technical Data, publication 5094-TD001	Provides FLEX 5000 EtherNet/IP adapters and FLEX 5000 I/O modules specifications.
FLEX 5000 Removable Terminal Blocks Product Information, publication 5094-PC001	Provides wiring information for the FLEX 5000 removable terminal blocks.
EtherNet/IP Communication Modules in Logix 5000 Control Systems User Manual, publication ENET-UM004	Describes how to install, configure, and operate EtherNet/IP Communication Modules in Logix 5000 Control Systems.
FLEX 5000 Digital I/O Modules User Manual, publication 5094-UM001	Provides information on how to install, configure, and operate FLEX 5000 digital I/O modules.
FLEX 5000 Analog I/O Modules User Manual, publication 5094-UM002	Provides information on how to install, configure, and operate FLEX 5000 analog I/O modules.
FLEX 5000 High-speed Counter Module User Manual, publication 5094-UM003	Provides information on how to install, configure, and operate the FLEX 5000 High-speed Counter Module.
Ethernet Design Considerations Reference Manual, publication ENET-RM002	Describes how to use EtherNet/IP adapters with Logix 5000 controllers and communicate with other devices on the EtherNet/IP network.
EtherNet/IP Embedded Switch Technology Application Guide, publication ENET-AP005	Describes how to install, configure, and maintain linear and Device Level Ring (DLR) networks by using Allen-Bradley® EtherNet/IP devices that are equipped with embedded switch technology.
EtherNet/IP Media Planning and Installation Manual This manual is available from the Open DeviceNet Vendor Association (ODVA) at http://www.odva.org	Describes how to use the required media components and provides information on how to plan for, install, verify, troubleshoot, and certify your EtherNet/IP network.
Industrial Automation Wiring and Grounding Guidelines, publication 1770-4.1	Provides general guidelines for installing a Rockwell Automation industrial system.
Product Certifications website, http://www.rockwellautomation.com/global/certification/overview.page	Provides declarations of conformity, certificates, and other certification details.

You can view or download publications at <http://www.rockwellautomation.com/literature/>. To order paper copies of technical documentation, contact your local Allen-Bradley distributor or Rockwell Automation sales representative.

Rockwell Automation Support

Use the following resources to access support information.

Technical Support Center	Knowledgebase Articles, How-to Videos, FAQs, Chat, User Forums, and Product Notification Updates.	https://rockwellautomation.custhelp.com/
Local Technical Support Phone Numbers	Locate the phone number for your country.	http://www.rockwellautomation.com/global/support/get-support-now.page
Direct Dial Codes	Find the Direct Dial Code for your product. Use the code to route your call directly to a technical support engineer.	http://www.rockwellautomation.com/global/support/direct-dial.page
Literature Library	Installation Instructions, Manuals, Brochures, and Technical Data.	http://www.rockwellautomation.com/global/literature-library/overview.page
Product Compatibility and Download Center (PCDC)	Get help determining how products interact, check features and capabilities, and find associated firmware.	http://www.rockwellautomation.com/global/support/pcdc.page

Documentation Feedback

Your comments will help us serve your documentation needs better. If you have any suggestions on how to improve this document, complete the How Are We Doing? form at http://literature.rockwellautomation.com/idc/groups/literature/documents/du/ra-du002_-en-e.pdf.

Rockwell Automation maintains current product environmental information on its website at <http://www.rockwellautomation.com/rockwellautomation/about-us/sustainability-ethics/product-environmental-compliance.page>.

Allen-Bradley, FLEX 5000, Logix 5000, Rockwell Automation, Rockwell Software, and Studio 5000 Logix Designer are trademarks of Rockwell Automation, Inc.
EtherNet/IP is a trademark of ODVA, Inc.

Trademarks not belonging to Rockwell Automation are property of their respective companies.

Rockwell Otomasyon Ticaret A.Ş., Kar Plaza İş Merkezi E Blok Kat:6 34752 İçerenköy, İstanbul, Tel: +90 (216) 5698400

www.rockwellautomation.com

Power, Control and Information Solutions Headquarters

Americas: Rockwell Automation, 1201 South Second Street, Milwaukee, WI 53204-2496 USA, Tel: (1) 414.382.2000, Fax: (1) 414.382.4444

Europe/Middle East/Africa: Rockwell Automation NV, Pegasus Park, De Kleetlaan 12a, 1831 Diegem, Belgium, Tel: (32) 2 663 0600, Fax: (32) 2 663 0640

Asia Pacific: Rockwell Automation, Level 14, Core F, Cyberport 3, 100 Cyberport Road, Hong Kong, Tel: (852) 2887 4788, Fax: (852) 2508 1846

Publication 5094-IN001B-EN-P - May 2018

Supersedes Publication 5094-IN001A-EN-P - February 2018

PN-485711

Copyright © 2018 Rockwell Automation, Inc. All rights reserved. Printed in Singapore.